

Los ventiladores GEMINI proporcionan el máximo rendimiento, durabilidad y es fácil de instalar en una amplia variedad de techos y/o líneas de ventilación.

- * GC 122-184
Capacidad: 28 a 262 CFM.
Presión estática: 0"-1.0".
Tamaño de las ruedas: 5.625"-7.625".



- * GC 220-740
Capacidad: 73 a 852 CFM.
Presión estática: 0"-1.0".
Tamaño de las ruedas: 4.75"-6.31".



- * GC 822-960
Capacidad: 830 a 1,807 CFM.
Presión estática: 0"-1.0".
Tamaño de las ruedas: 8".



- * GN 122-184
Capacidad: 40 a 260 CFM.
Presión estática: 0"-1.0".
Tamaño de las ruedas: 5.625"-7.625".

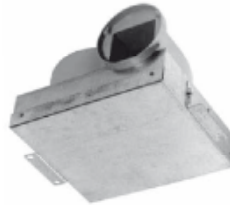

- * GN 822-960
Capacidad: 838 a 1875 CFM.
Presión estática: 0"-1.0".
Tamaño de las ruedas: 8".

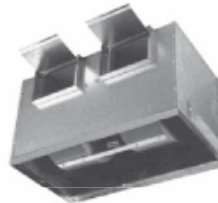

- * GN 1000-2000
Capacidad: 905 a 3,472 CFM.
Presión estática: 0"-1.0".
Tamaño de las ruedas: 8"-9.5".

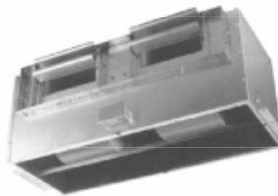

- * GN 220-740
Capacidad: 75 a 873 CFM.
Presión estática: 0"-1.0".
Tamaño de las ruedas: 4.75"-6.31".



- * GC 1000-2000
Capacidad: 905 a 3,472 CFM.
Presión estática: 0"-1.0".
Tamaño de las ruedas: 8"-9.5".

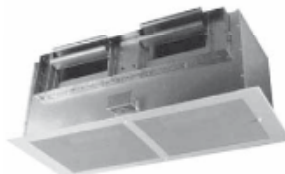

GC 122-184

| Grille Material | A | B | Unit Size | Approx. Ship-Wt. Lbs. |
|-----------------|--------|--------|-----------|-----------------------|
| Plastic | 13-1/4 | 14-3/4 | 122/12 | 13 |
| Steel | 13-1/2 | 15-1/2 | 142/14 | 15 |
| Aluminum | 12-3/4 | 14-3/4 | 162/164 | 15 |
| | | | 182/18 | 16 |

Todas las dimensiones en pulgadas.

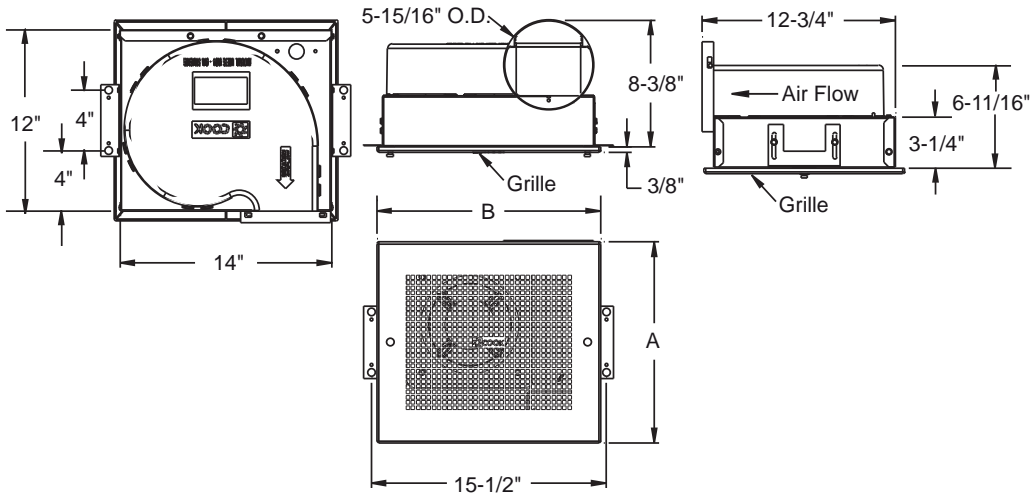

GC 220-960

| Model GC | Housing | | | Outlet | | Steel Grille | | Deluxe Aluminum Grille | | Approx. Ship-Wt. Lbs. |
|---------------|---------|----------|----------|--------|-------|--------------|--------|------------------------|--------|-----------------------|
| | L | W | H | A | B | J | K | J | K | |
| 220, 240 | 12-3/8 | 9-3/4 | 9-3/4 | 8 | 6 | 16-3/8 | 13-5/8 | 13-1/4 | 10-1/4 | 22 |
| 320, 340 | 12-3/8 | 10-3/4 | 10-3/4 | 8 | 6 | | | 13-1/4 | 11-1/4 | |
| 420 | 17 | 11-7/8 | 11-7/8 | 8 | 6 | 21 | 14-1/4 | 17-3/4 | 12-3/4 | 30 |
| 520 | 17 | 11-7/8 | 11-7/8 | 8 | 6 | 21 | 14-1/4 | 17-3/4 | 12-3/4 | |
| 620, 640 | 17 | 11-7/8 | 11-7/8 | 10-1/2 | 4-3/4 | 21 | 14-1/4 | 17-3/4 | 12-3/4 | 35 |
| 720, 740 | 17 | 11-7/8 | 11-7/8 | 10-1/2 | 4-3/4 | 21 | 14-1/4 | 17-3/4 | 12-3/4 | |
| 822, 842, 862 | 27 | 14-11/16 | 14-11/16 | 20 | 6 | 31-3/8 | 17-1/8 | 27-3/4 | 15-1/4 | 74 |
| 920, 940, 960 | 31 | 14-11/16 | 14-11/16 | 24-1/4 | 6 | 35-1/8 | 17-1/8 | 31-3/4 | 15-1/4 | |

Todas las dimensiones en pulgadas.

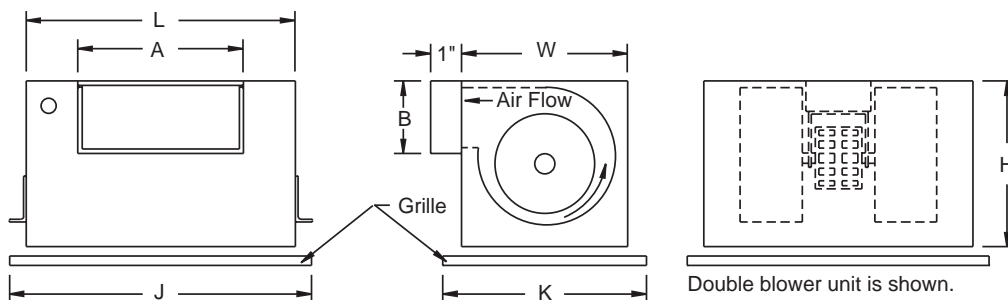

Double blower unit is shown.

GN 122-184

| Model GN | Approx. Ship-Wt. Lbs. |
|---------------|-----------------------|
| GN-122/GN-124 | 15 |
| GN-142/GN-144 | 15 |
| GN-162/GN-164 | 16 |
| GN-182/GN-184 | 16 |

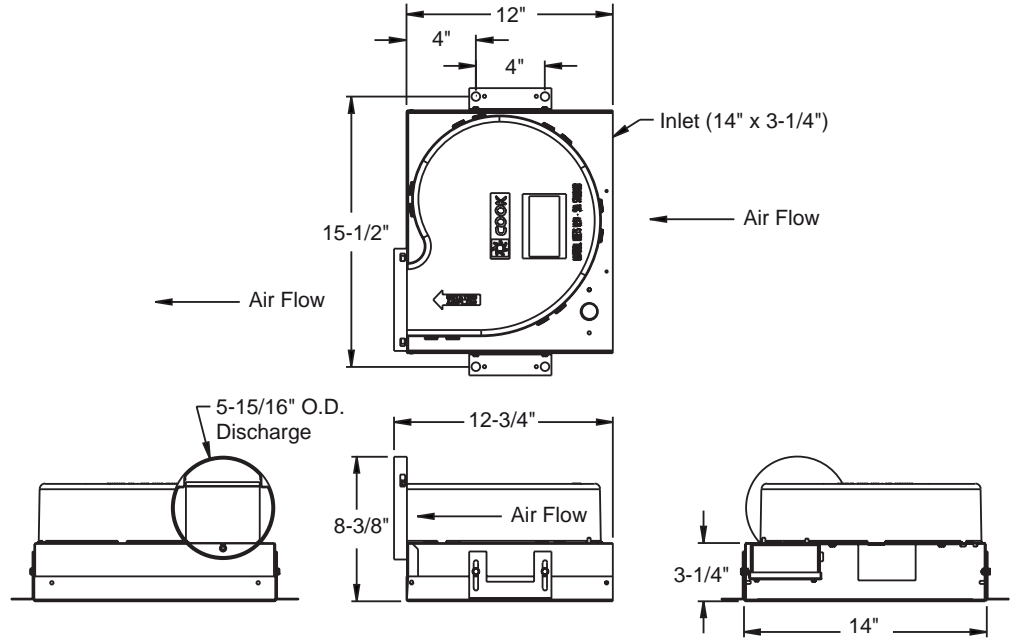

GN 220-960

| Model GN | Housing | | | Outlet | | Inlet Collar | | Approx. Ship-Wt. Lbs. |
|---------------|---------|----------|----------|--------|-------|--------------|----------|-----------------------|
| | L | W | H | A | B | J | K | |
| 220, 240 | 12-3/8 | 9-3/4 | 9-3/4 | 8 | 6 | 12-5/16 | 9-11/16 | 22 |
| 320, 340 | 12-3/8 | 10-3/4 | 10-3/4 | 8 | 6 | 12-5/16 | 10-11/16 | 25 |
| 420 | 17 | 11-7/8 | 11-7/8 | 8 | 6 | 16-15/16 | 11-15/16 | 30 |
| 520 | 17 | 11-7/8 | 11-7/8 | 8 | 6 | 16-15/16 | 11-15/16 | 32 |
| 620, 640 | 17 | 11-7/8 | 11-7/8 | 10-1/2 | 4-3/4 | 16-15/16 | 11-15/16 | 35 |
| 720, 740 | 17 | 11-7/8 | 11-7/8 | 10-1/2 | 4-3/4 | 16-15/16 | 11-15/16 | 36 |
| 822, 842, 862 | 27 | 14-11/16 | 14-11/16 | 20 | 6 | 27 | 14-1/2 | 74 |
| 920, 940, 960 | 31 | 14-11/16 | 14-11/16 | 24-1/4 | 6 | 31 | 14-1/2 | 86 |

Todas las dimensiones en pulgadas.

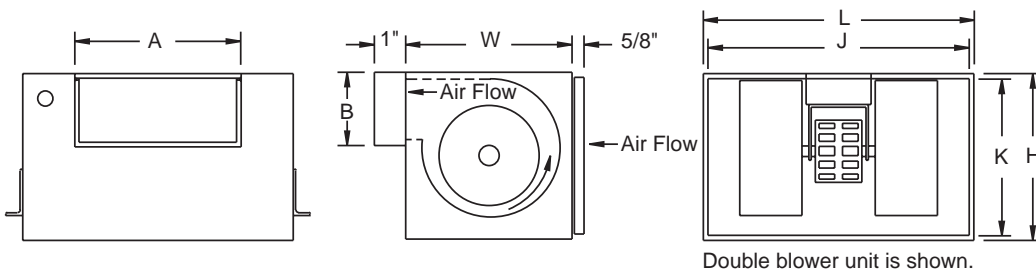

GN 1000-2000

| Model GN | Housing | | | Outlet | | Standard Grille | | Approx. Ship-Wt. Lbs. |
|----------|---------|--------|--------|----------|---------|-----------------|--------|-----------------------|
| | L | W | H | A | B | J | K | |
| GN-1000 | 38-1/8 | 15-1/4 | 15-1/4 | 33-11/16 | 7-11/16 | 42-3/8 | 17-1/8 | 125 |
| GN-2000 | 45-7/16 | 16-5/8 | 16-5/8 | 41-1/8 | 9-5/8 | 49-1/2 | 18-1/2 | 165 |

Todas las dimensiones en pulgadas.

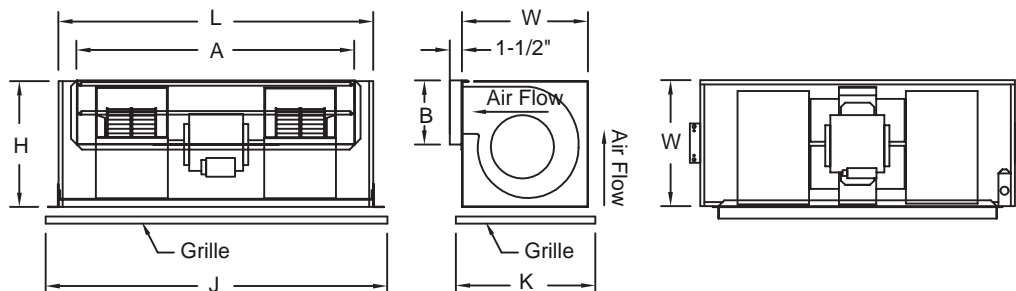

GC 1000-2000

| Model GC | Housing | | | Outlet | | Standard Grille | | Deluxe Aluminum Grille | | Approx. Ship Wt. Lbs. |
|----------|---------|--------|--------|----------|---------|-----------------|--------|------------------------|--------|-----------------------|
| | L | W | H | A | B | J | K | J | K | |
| GC-1000 | 38-1/8 | 15-1/4 | 15-1/4 | 33-11/16 | 7-11/16 | 42-3/8 | 17-1/8 | 38-3/4 | 15-3/4 | 125 |
| GC-2000 | 45-7/16 | 16-5/8 | 16-5/8 | 41-1/8 | 9-5/8 | 49-1/2 | 18-1/2 | 45-3/4 | 17-1/4 | 165 |

Todas las dimensiones en pulgadas.

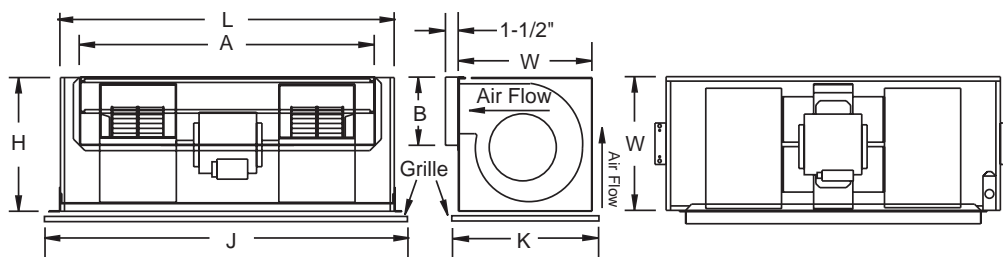

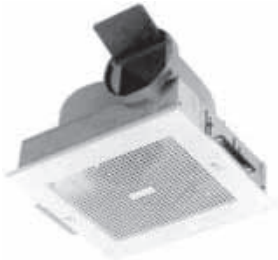

GC 122-184

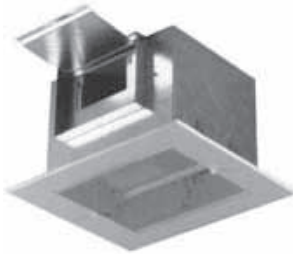

GC 220-740



GC 822-960



GC 1000-2000

GC 122-144

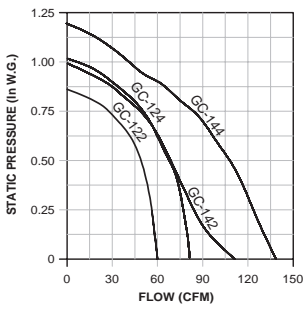

GC 162-184

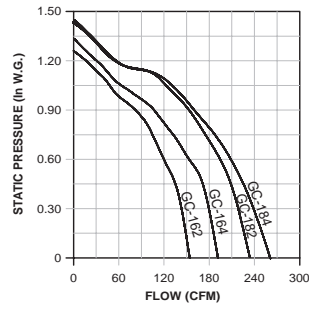

GC 220-240

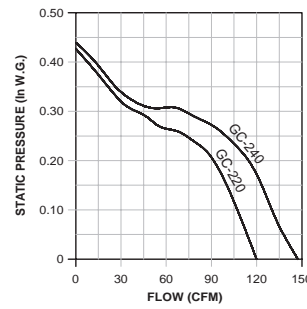

GC 320-340

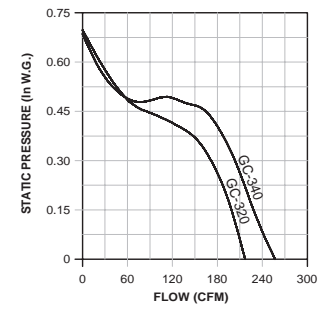

GC 420

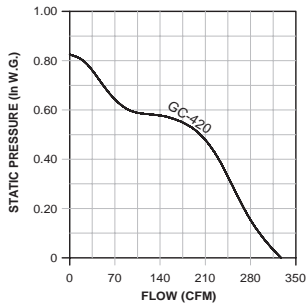

GC 520

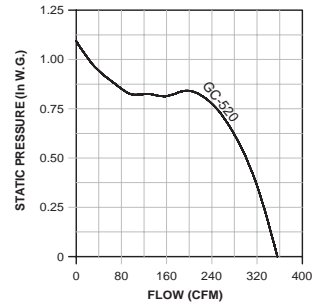

GC 620-640

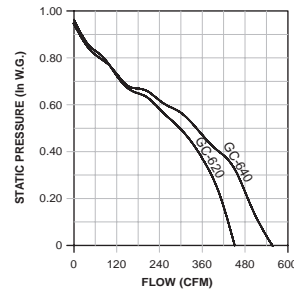

GC 720-740

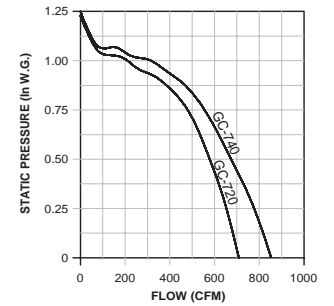

GC 822-842

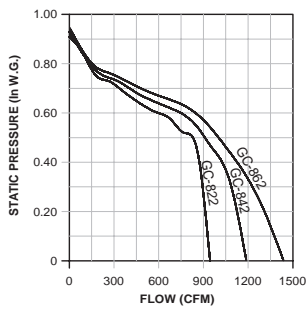

GC 920-960

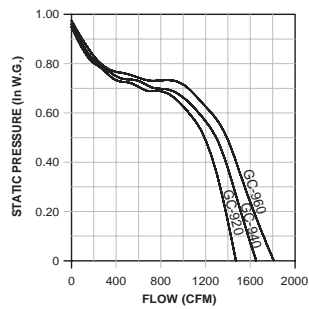

GC 1000

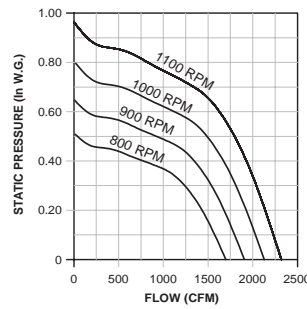

GC 2000

